









(1) x1 	(D) x1 
(2) x1 	(E) x4 
(3) x4 	(F) x8 
(A) x8 M6*43 	(G) x8 
(B) x4 M6*14 	 X1
(C) x1 	 5min

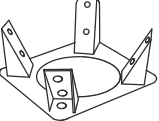
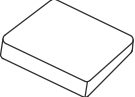
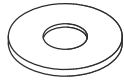
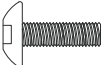
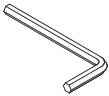
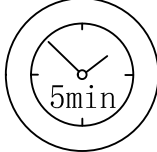